

Basic Information

Ecoshel Shingle-Strips come in different configurations that are evenly distributed in the cartons. You don't need to be aware of the different strips. Each strip includes the same three guide marks. Each time you start a new course, you align the edge of the first Shingle-Strip with one of these three guide marks. Starting each new course at one of the guide marks offsets the joints from course to course, and provides a random installation. Review the complete installation instructions below.

Ecoshel cedar shingles are real wood. Minor defects and variations are part of the character of the product. If you damage a Shingle-Strip, set it aside to cut up for detail work or corners, or to be used as a cut strip at the beginning or end of a course.

Ecoshel shingles are kiln dried. The gap between shingles is necessary to allow the shingles to expand when they absorb moisture.

The prefabricated assembly is non-structural. It holds the shingles in position until they are fastened conventionally.

Always pick up and handle Shingle-Strips by holding the top edge.

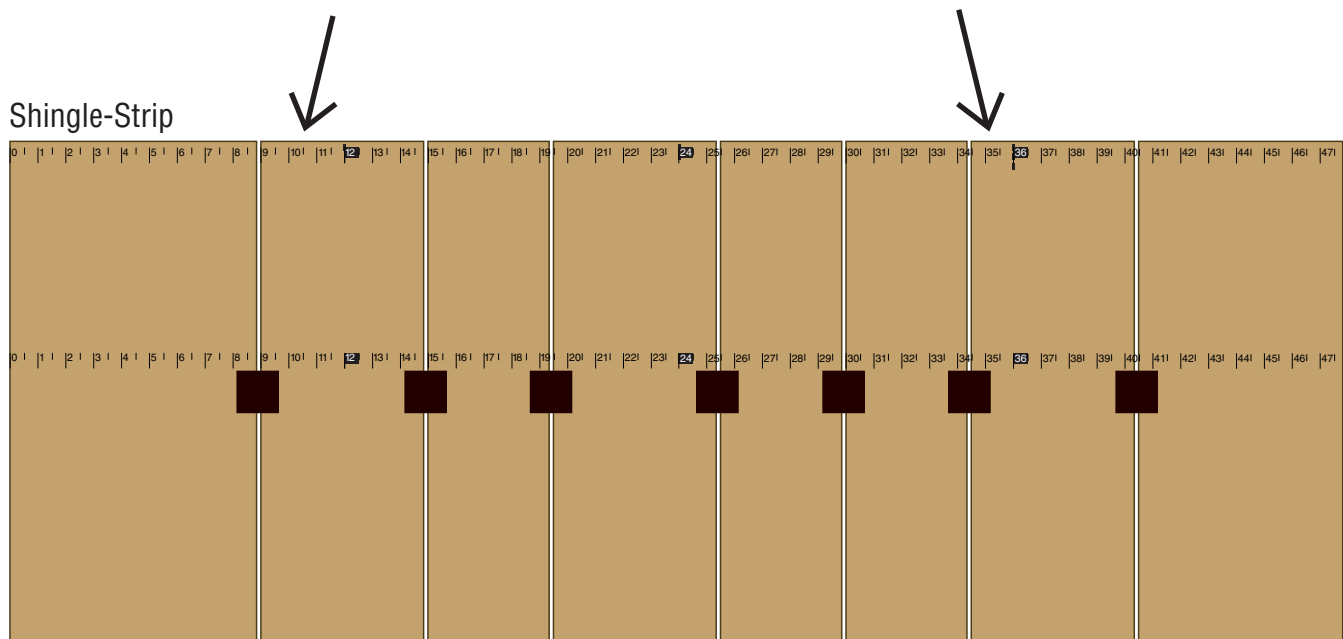

Sheathing, underlayment, and flashing

Ecoshel Cedar Shingles must be installed on solid sheathing with a minimum thickness of 1/2", or on 1 x ____ spaced sheathing. Plywood, oriented strand board, or solid lumber may be used. The recommended underlayment is 30 pound asphalt impregnated felt. In northern climates, an ice and water shield should be installed along eaves at the width specified by local codes. Proper standard flashing must be used at all intersections with vertical surfaces (chimneys, dormers, etc.). Do not use steel core flashing as it will cause black stains. Copper or zinc flashings will help preserve the shingles (see the hip and ridge section for more information).

Fasteners

Stainless steel fasteners are essential to avoid black streaks. Stainless ring shank coil siding nails are recommended. Use 4D ring shank nails with a minimum length of 1-3/4". If the underlayment or deck is thicker, or if there is rigid foam between the deck and the Shingle-Strips, use longer nails. Nails should pass completely through the sheathing. Roofing nails with the oversize head and wider shank should not be used.

Using a coil siding nail gun will provide the fastest installation. Drive nails tight to the surface of the shingle, **but don't overdrive. Nail heads should not be buried in the wood fiber.** Medium crown staples are approved by code, but will not hold as well as ring shank nails.

Cutting

Ecoshel Shingle-Strips can be separated at the clips by cutting the clips with a sharp utility knife, or by cutting the mesh tape on the back on either side of the clip, and then prying out the clip from the front. Also cut the mesh tape along the top of the Shingle-Strip.

Strips can also be cut with lightweight circular saws, jigsaws, or on a table saw.

A long saw table with a saw guide is essential to enable the system to be installed precisely and quickly. If you don't have a saw table, you can make one easily with a half sheet of plywood or OSB. See the Saw Table section in these instructions.

Establish a location where shingle-strip cut-offs can be kept until they are needed.

INSTALLATION ON SOLID SHEATHING

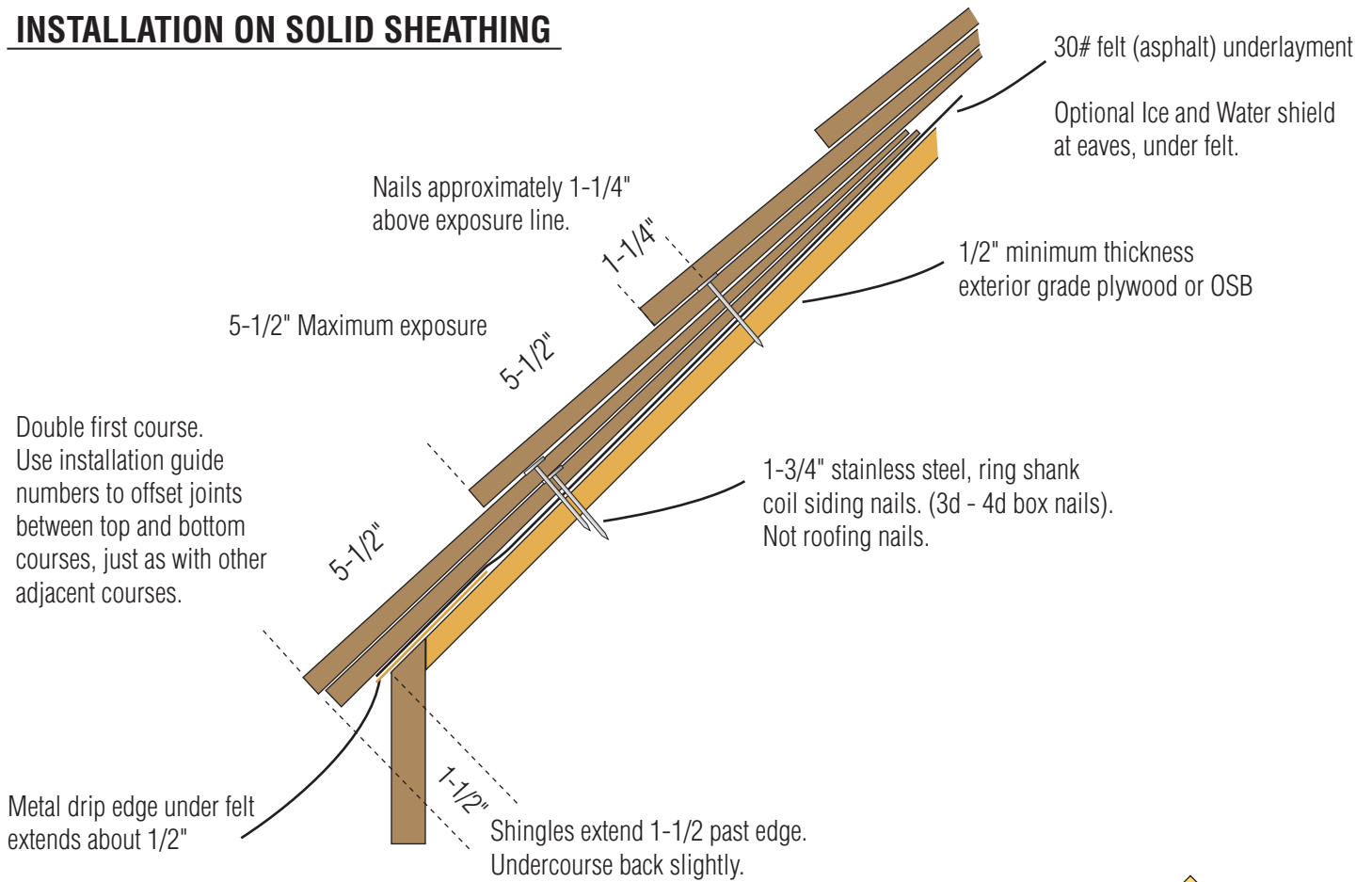

INSTALLATION ON SPACED SHEATHING

SAME SPECIFICATIONS AS FOR SOLID SHEATHING ABOVE, plus 1 x 4s spaced as shown.

Felt (and optional ice and water shield) under at least 1st course.

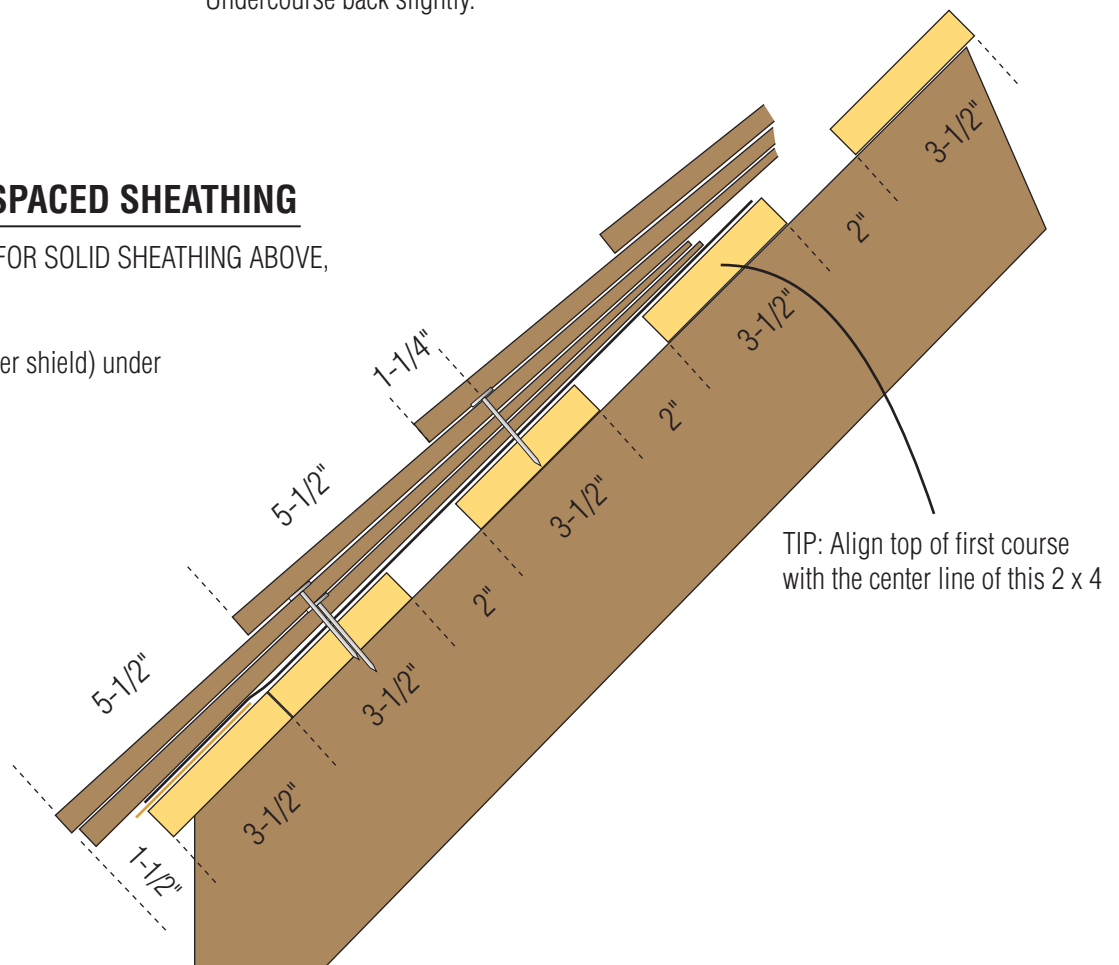

INSTALLATION ON FURRING STRIPS OVER SOLID SHEATHING

SAME SPECIFICATIONS AS FOR SOLID SHEATHING ABOVE,
plus 1 x 4s spaced on vertical strips as shown.

The Ecoshel System includes a built-in ventilated rain-screen that provides a slight vent space and capillary break between shingle courses, and between shingles and the underlayment.

Additional air space, as shown in this installation, is not required.

If additional space is created, the venting requirement will increase. Trim at the eave should be designed to create a screened vent. A ridge vent should also be used. Venting should be continuous from eave to ridge vent.

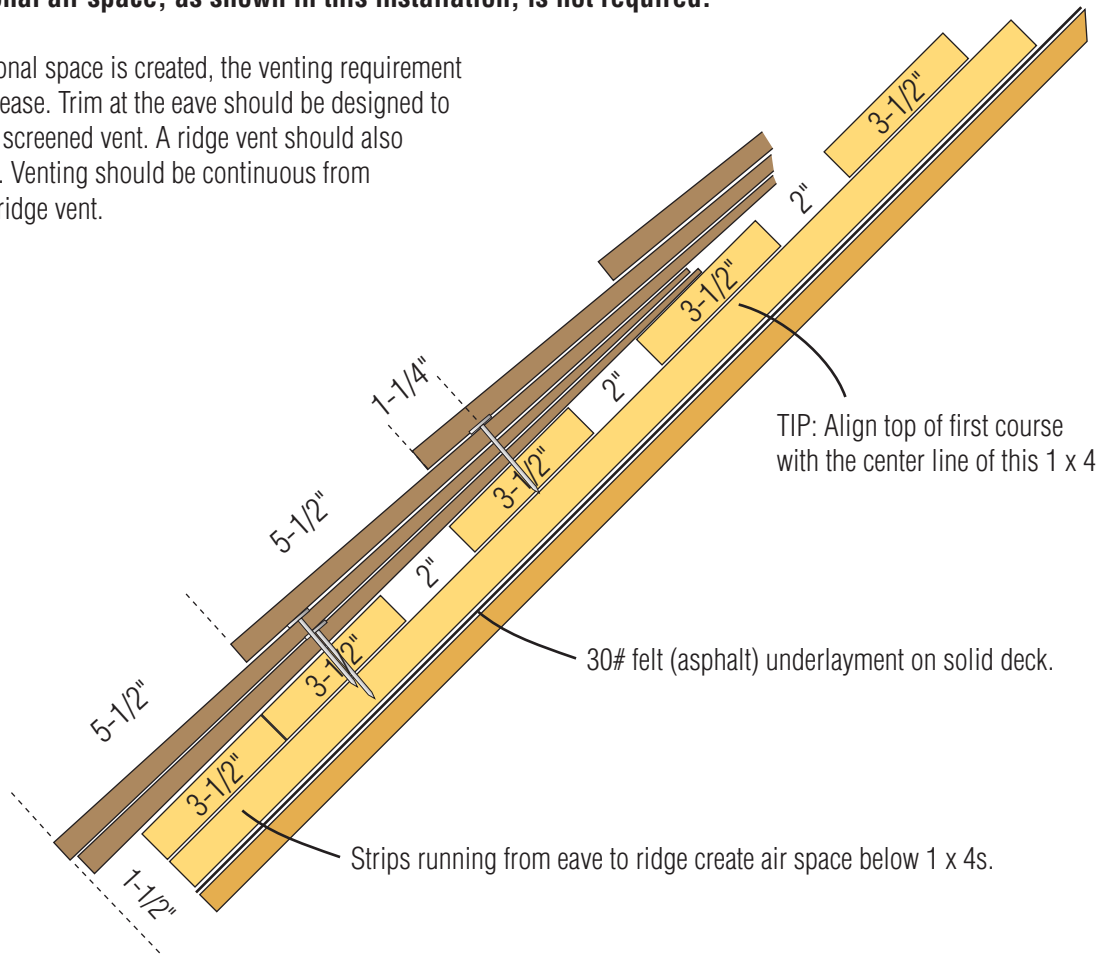

Trim at eave should be designed to allow airspace to be vented from eave to ridge vent.

General Instructions

Install The First Course

Install Each Course Maintaining the full Shingle Strip pattern through dormers and chimneys. Use only one starting point.

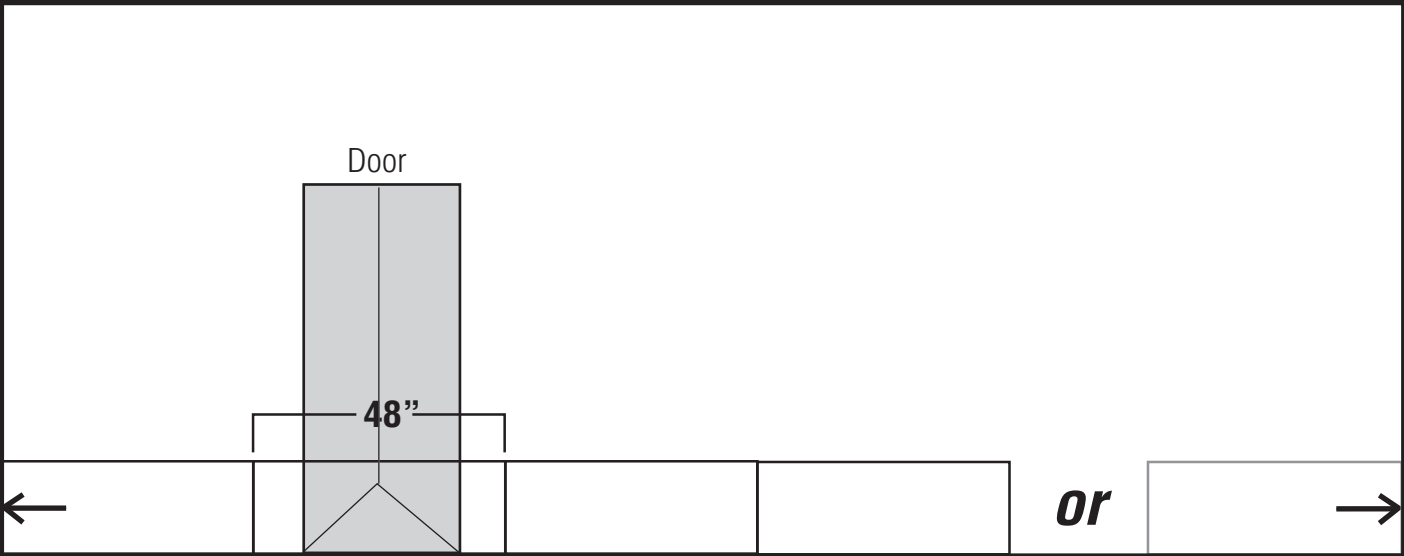

For the first course, you can start installing Strips from either gable end, or from any convenient point in the middle of the roof. You don't need to start at edge of the roof.

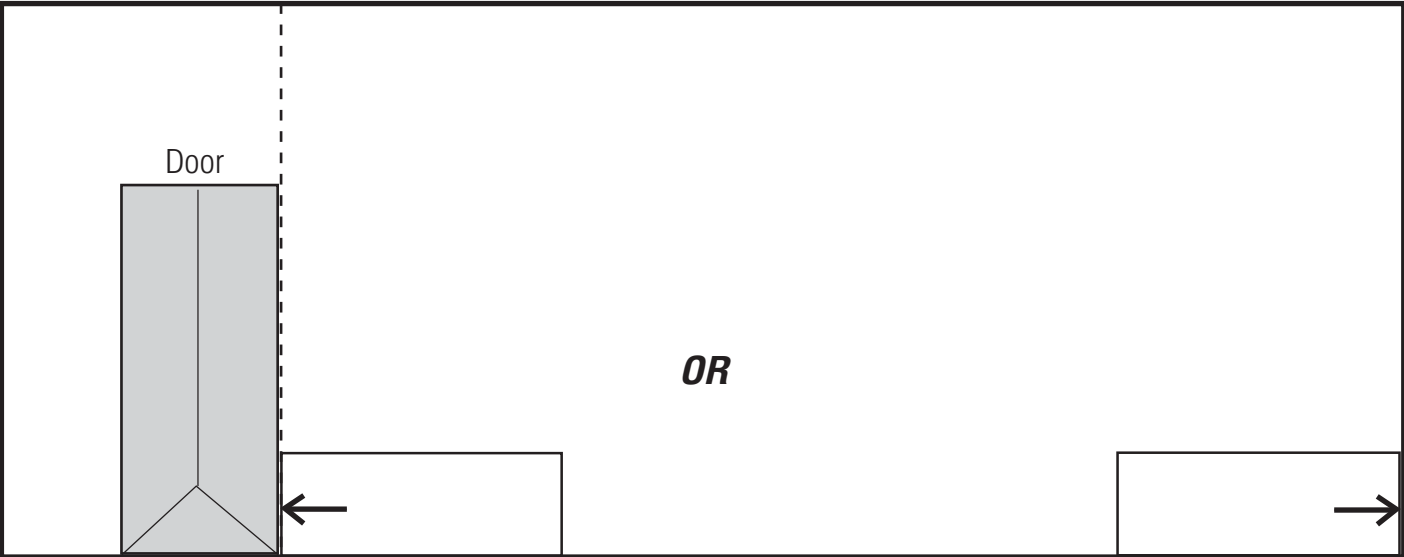

Install the first course allowing a 3/16" gap between Shingle-Strips. Its 48" from any point on one Shingle-Strip to the same point on the next. Double the first course as shown. Use the guide marks to offset the joints between the top and bottom courses, just as you will for adjacent courses.

Fasten Each Shingle

Fasten each shingle using ONLY two nails per shingle, 3/4" in from each edge, and approximately 1-1/4" above the exposure line (the butt line of the next course).

The bottom of the shingle clip is 8" above the butt and can be used as a visual reference for the nail position. The nail head should be near flush to the inside of the clip. The exact position of the nail isn't critical. Try to be within about 1/4 inch of the target.

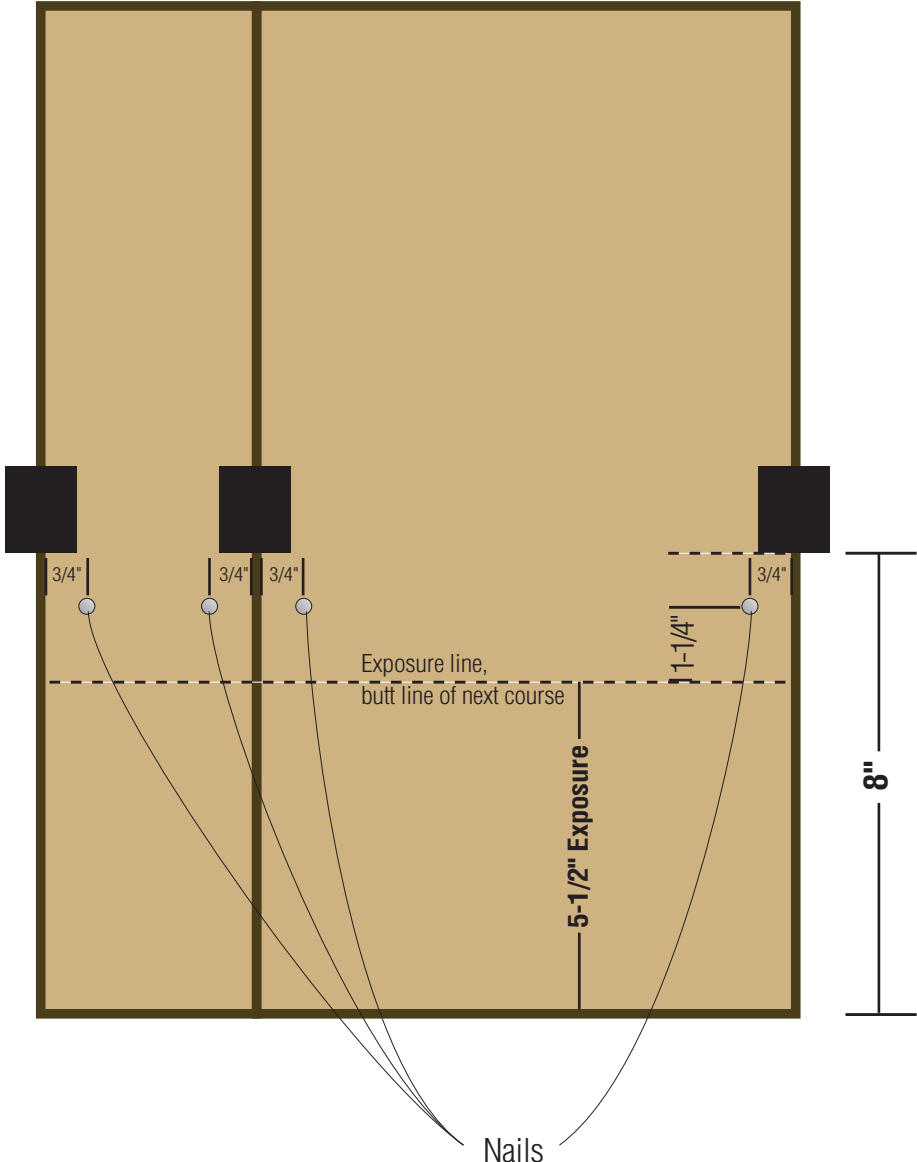

Position and Install the Next Course.

NOTE: THE FIRST COURSE MUST BE DOUBLED. TO DOUBLE THE FIRST COURSE, USE THIS SAME ALIGNMENT PROCEDURE WITH AN EXPOSURE = 0.

Use chalk lines as your guide to position each course. Ecoshel Shingle-Strips are trimmed to 17-1/2". Snap a chalk line on the felt paper above the top edge of the first course, at a distance equal to the desired exposure. You can make additional lines at the exposure interval all the way up the roof. You may want to adjust the exposure slightly to control how the courses align with chimneys, dormers, etc. as well as to control the height of the last course.

Alignment Procedure: Each time you start a new course, align the left edge of a Shingle-Strip at the 12, 24, or 36" guide mark on any Shingle-Strip in the previous course. The edge should align with the left side of the black box. You can install the first strip anywhere in the course. **CHOOSE A GUIDE MARK THAT OFFSETS THE JOINTS FROM THE JOINTS IN THE PREVIOUS TWO COURSES. YOU MUST CHECK TO MAKE SURE YOUR JOINTS ARE OFFSET WHEN YOU INSTALL THE FIRST SHINGLE STRIP OF EACH COURSE. NOT ALL GUIDE MARKS WILL PROVIDE JOINT OFFSETS OVER 2 COURSES. ONE POSITION WILL MATCH.**

After the first strip is installed, continue installing full Shingle-Strips to the left and right until the course is complete. You don't need to check the joint offsets after the first strip in the new course is installed. When crossing obstructions, you can measure across the opening. (It's 48" from any point on a strip to the same point on the next strip), or you can realign again with the previous course using the same guide mark.

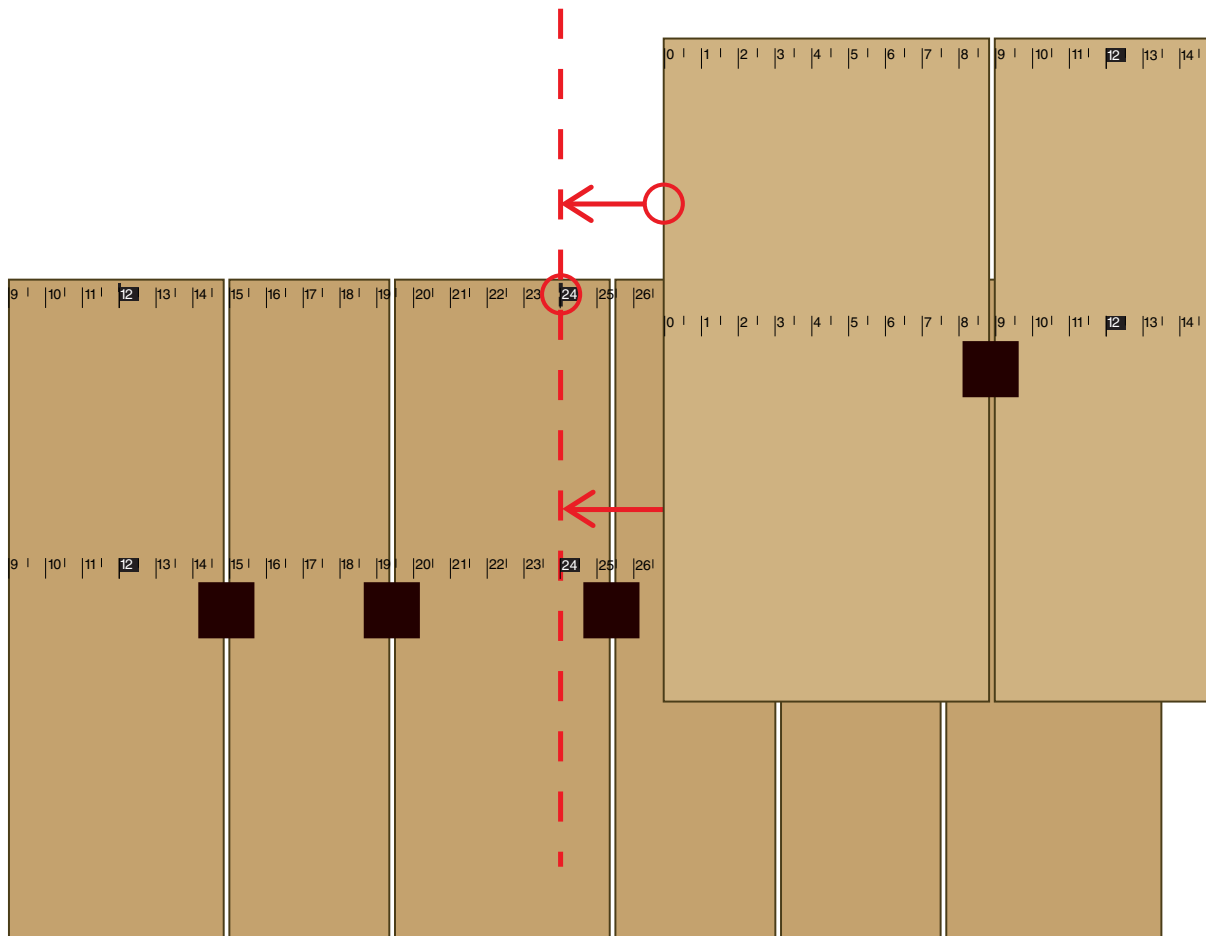

Plan the Installation

Determine the “exposure” you will use (how much of the shingle will be exposed - the height of each course). The maximum recommended exposure for slopes of 4 in 12 or steeper is 5-1/2”.

Make adjustments to the exposure to control how each course aligns with dormers, chimneys, etc.

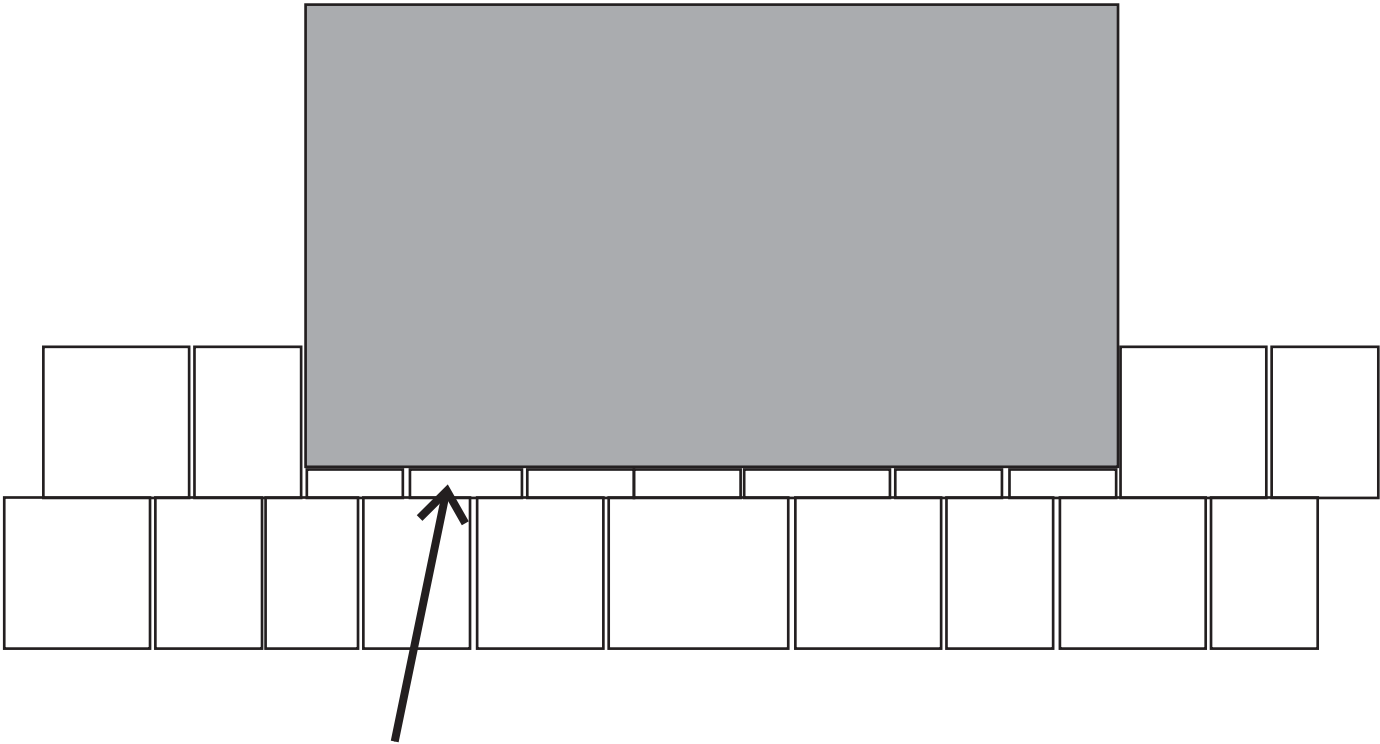

Avoid alignments that require attaching small sections of shingles below dormers or chimneys, or at the ridge.

The amount of exposure can be gradually changed to provide better alignment.

Ending a Course

At the end of a course, (gable edge, wall, chimney, etc.) it's easiest to cut the shingle-strip with a knife at the last joint, and install it. Then cut and install the last shingle from any of the cut-off sections. A helper can be cutting the last shingle while you are installing the shingle-strip, rather than passing it back and forth.

If the last shingle will be too narrow, cut the shingle-strip at the previous joint.

TIP:

You can save a lot of time by letting the shingles run "wild" (past the 1" overhang) and then trimming all of them at once. You can also ruin a lot of work fast with this procedure. A saw guide is recommended. A 1/4" PVC or plywood base attached to a 2 x 2 works well. (below)

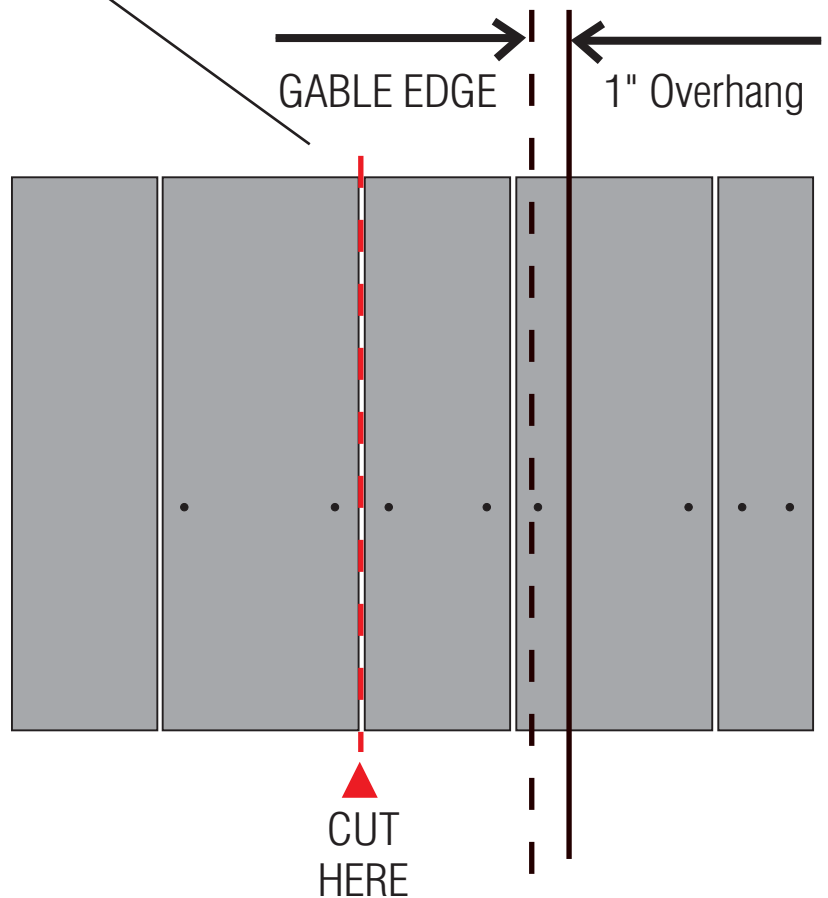
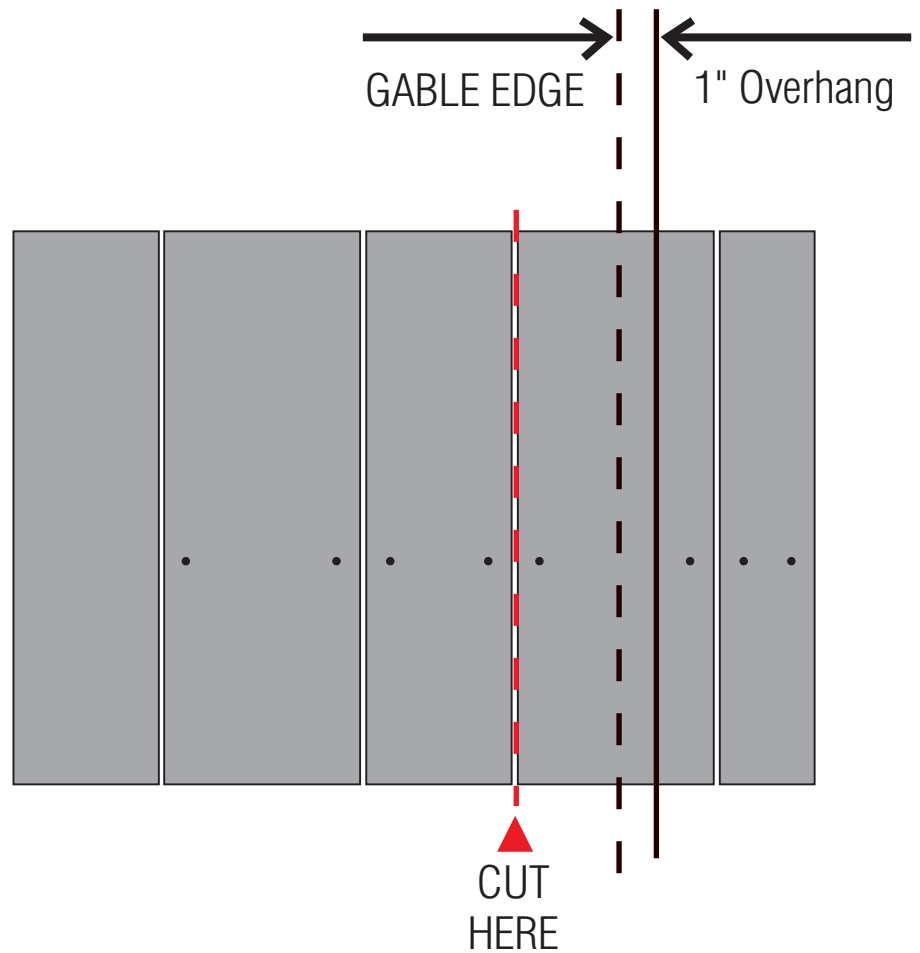
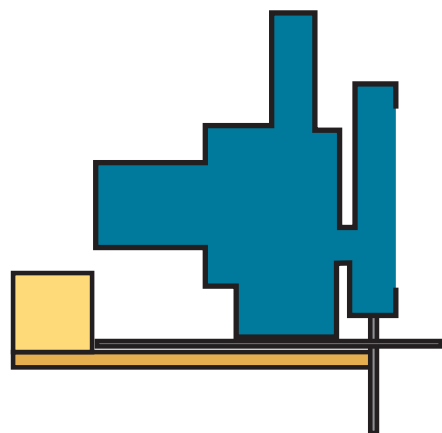

Hip and Ridge Shingles

Pre-assembled hip and ridge shingles are available from Ecoshel.

Felt, or flashing should be installed under the hip and ridge units.

Zinc, galvanized, or copper flashing that extends out beyond the edge of the ridge shingles by at least an inch, will help to preserve the shingles for a distance of up to 15 feet below the flashing.

The zinc or copper dissolves slightly into rain water and washes the shingles below with a solution that kills decay fungi and anything else that might grow on the surface. For roofs with a slope longer than 15 feet, a second copper band can be tucked under a course of shingles further down the slope. At least 1" of the copper should be exposed to the weather.

Install hip and ridge shingles starting with the butt end at the eave or rake edge. Use a 5-1/2" exposure and concealed nailing, just like the shingles in the field. Use two nails in each unit, 3/4" in from the edge, and 1-1/2" under the butt of the next shingles. Longer nails are required for the hip and ridge shingles, typically at least 2-1/8 inch. The first course should be doubled. Joints should alternate left and right for all adjacent courses.

Using a formed copper ridge cap rather than ridge shingles, will also provide excellent protection for the shingles below.

Making a Saw Table

A saw table makes the installation much easier. The easiest way to set up a table is to make a 24" x 96" top with OSB or plywood held straight by a 2 x 4 frame beneath, and then set the frame on saw horses.

A small lightweight battery powered circular saw works well for cutting the shingles.

Install a 1 x 3 strip along the back of the table, with a gap in the strip to allow the circular saw to pass through.

Use a triangle as a saw guide. Tape a thin plastic sheet to the bottom of the triangle and cut it with the saw guided by the triangle. This provides a blade position indicator.

Place the Shingle-Strip on the table with the cut mark above the blade channel. Then place the triangle on the Shingle-Strip with the blade position indicator at the cut mark.

